

P35F FRAME system

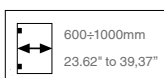

- Kit profilo telaio per porte in vetro con cerniera integrata. Da abbinare a P35E.
- Perfil marco kit para puertas en vidrio con bisagra integrada. Combinar con P35E.
- Profile kit for glass doors with integrated hinge. To be matched with P35E.
- Zargenprofil Set für Glastüren mit integriertem Scharnier. Mit P35E kombinierbar.
- Profilé set pour porte en verre avec charnière intégrée. Avec P35E combiner.

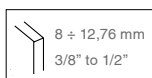
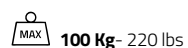

Kit composto da / Kit composed by



con / with

1 Scegli la versione / Choose the version



2 Scegli serratura o maniglia / Choose the lock or handle



OPTIONAL

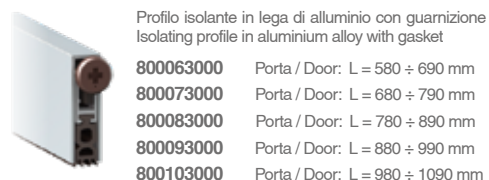

Profilo isolante in lega di alluminio con guarnizione
Isolating profile in aluminium alloy with gasket

- 800063000 Porta / Door: L = 580 ÷ 690 mm
- 800073000 Porta / Door: L = 680 ÷ 790 mm
- 800083000 Porta / Door: L = 780 ÷ 890 mm
- 800093000 Porta / Door: L = 880 ÷ 990 mm
- 800103000 Porta / Door: L = 980 ÷ 1090 mm

i P35F è concepito per essere utilizzato in abbinamento al nostro controtelaio P35E • P35F is designed to be used in combination with our P35E counterprofile

! ATTENZIONE! IL CONTROTELAIO P35E È DA ORDINARE A PARTE - ATTENTION! THE P35E COUNTERPROFILE MUST BE ORDERED SEPARATELY

P35E FRAME system



Fissaggio a muro / Wall fixing

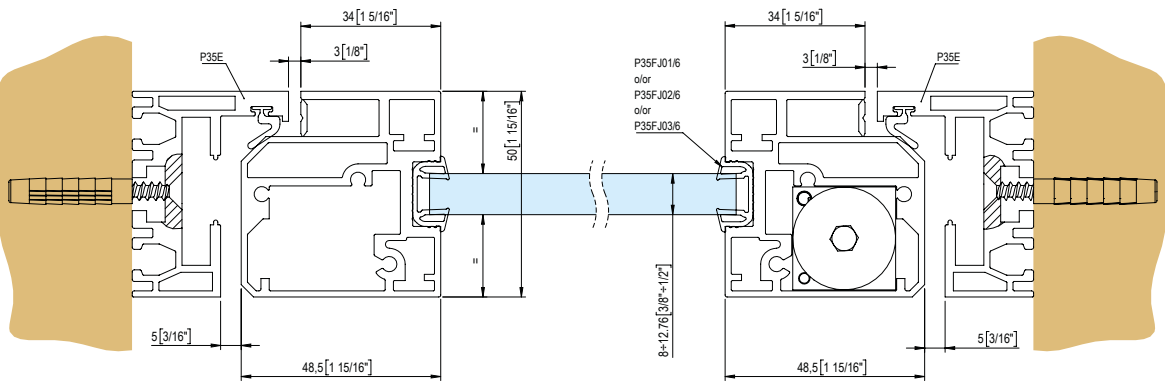

GUARNIZIONI PER VETRO PORTA
in base allo spessore del vetro

GASKETS FOR GLASS DOOR
based on the glass thickness

P35FJ01

8-8.76mm
5/16" - 3/8"

Coppia di guarnizioni L=8m.
Pair of gaskets L=8m.

P35FJ02

10-10.76mm
3/8" - 7/16"

Coppia di guarnizioni L=8m.
Pair of gaskets L=8m.

P35FJ03

12-12.76mm
1/2"

Coppia di guarnizioni L=8m.
Pair of gaskets L=8m.

P35F + P35E60 + P35E61

Fissaggio a vetro / Glass fixing

Spessore / Thickness 8 - 13.52 mm [5/16" to 9/16"]

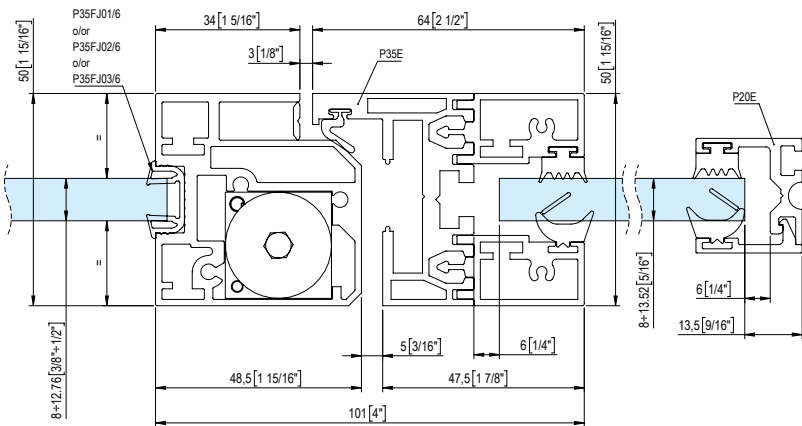

Guarnizioni per fissaggio a vetro
in base allo spessore del vetro

Gaskets for glass fixing
based on the thickness of the glass

P20EJ0810/6

8-10.76mm
5/16" - 7/16"

Coppia di guarnizioni L=5.8m.
Pair of gaskets L=5.8m.

P20EJ1113/6

11.52-13.52mm
7/16" - 9/16"

Coppia di guarnizioni L=5.8m.
Pair of gaskets L=5.8m.

P35F + P35E60 + P35E62

Fissaggio a vetro / Glass fixing

Spessore / Thickness 16.76 - 21.52 mm [11/16" to 7/8"]

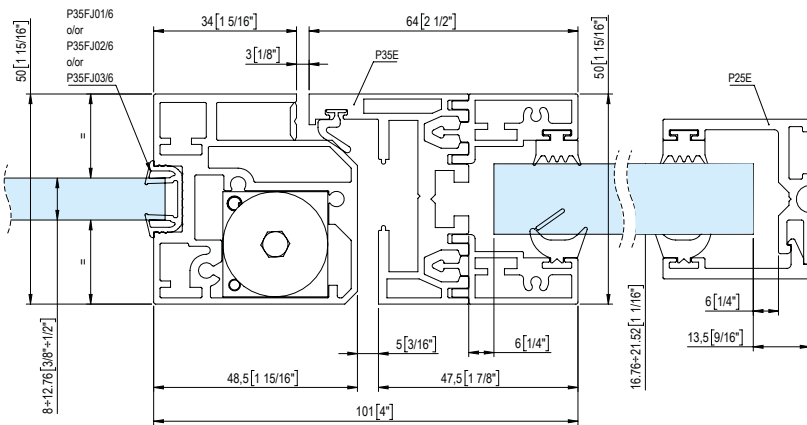

Guarnizioni per fissaggio a vetro
in base allo spessore del vetro

Gaskets for glass fixing
based on the thickness of the glass

P20EJ0810/6

16.76-17.52mm
11/16"

Coppia di guarnizioni L=5.8m.
Pair of gaskets L=5.8m.

P20EJ1113/6

20.76 - 21.52mm
13/16" - 7/8"

Coppia di guarnizioni L=5.8m.
Pair of gaskets L=5.8m.